



King's Research Portal

DOI:

[10.1161/circep.113.000591](https://doi.org/10.1161/circep.113.000591)

Document Version

Publisher's PDF, also known as Version of record

[Link to publication record in King's Research Portal](#)

Citation for published version (APA):

Dhanjal, T., Medina, R., Leem, J., Clark, J., Southworth, R., & Curtis, M. (2013). Trapped Platelets Activated in Ischemia Initiate Ventricular Fibrillation. *Circulation-Arrhythmia And Electrophysiology*, 6(5), 995-1001. Article N/A. <https://doi.org/10.1161/circep.113.000591>

Citing this paper

Please note that where the full-text provided on King's Research Portal is the Author Accepted Manuscript or Post-Print version this may differ from the final Published version. If citing, it is advised that you check and use the publisher's definitive version for pagination, volume/issue, and date of publication details. And where the final published version is provided on the Research Portal, if citing you are again advised to check the publisher's website for any subsequent corrections.

General rights

Copyright and moral rights for the publications made accessible in the Research Portal are retained by the authors and/or other copyright owners and it is a condition of accessing publications that users recognize and abide by the legal requirements associated with these rights.

- Users may download and print one copy of any publication from the Research Portal for the purpose of private study or research.
- You may not further distribute the material or use it for any profit-making activity or commercial gain
- You may freely distribute the URL identifying the publication in the Research Portal

Take down policy

If you believe that this document breaches copyright please contact librarypure@kcl.ac.uk providing details, and we will remove access to the work immediately and investigate your claim.

Trapped Platelets Activated in Ischemia Initiate Ventricular Fibrillation

Tarvinder S. Dhanjal, PhD, MRCP; Rodolfo A. Medina, PhD; Jinwoo Leem, MSc; James E. Clark, PhD; Richard Southworth, PhD; Michael J. Curtis, PhD, FBPharmS

Background—We tested the hypothesis that ischemia-induced ventricular fibrillation (VF) is facilitated by platelets, trapped regionally in the ischemic zone and activated to release arrhythmogenic secretome.

Methods and Results—In a randomized study in blood-free, buffer-perfused isolated rat hearts, ischemic zone territory (34±1% of left ventricle) was selected so that ischemia evoked VF in only 42% of controls. VF incidence was increased to 91% ($P<0.05$) by coronary ligation–induced trapping of freshly prepared autologous platelets (infused before and during coronary ligation, with trapping confirmed by ^{111}In -labeled platelet autoradiographic imaging). Trapping of platelet secretome prepared ex vivo, or platelet-sized fluorospheres, did not increase ischemia-induced VF incidence. Secretome alone did, however, evoke VF in 2 sham coronary-ligated hearts. Perfusion did not activate infused platelets in sham coronary-ligated hearts, whereas ligation activated trapped platelets (assessed by thromboxane release). In a separate study, trapping whole-heparinized blood mimicked the ability of trapped platelets to increase VF incidence. This effect was not prevented by >5 days oral pretreatment in vivo with clopidogrel (10 mg/kg per day) or indomethacin (2.4 mg/kg per day).

Conclusions—Platelets facilitate VF during acute ischemia independently of their ability to participate in occlusive thrombosis. Moreover, the effect is unresponsive to antiplatelet drugs commonly used. Labile secretome constituents appear to be responsible. This opens a novel avenue for antiarrhythmic drug research. (*Circ Arrhythm Electrophysiol.* 2013;6:995-1001.)

Key Words: arrhythmias, cardiac ■ antiarrhythmia agent ■ antiarrhythmic drug development ■ myocardial ischemia ■ blood platelets ■ death, sudden, cardiac

Ventricular fibrillation (VF), the principle cause of sudden cardiac death,^{1,2} is largely resistant to ion channel–targeting antiarrhythmic drugs.^{3–6} The pathophysiology of ischemia (that mediates the adverse electrophysiological milieu)⁷ may represent a more promising target.

Clinical Perspective on p 1001

Animal studies have shown that early (phase I) VF arises during the first 30 minutes of ischemia when arrhythmogenic substances accumulate,⁸ but it remains unclear which substances are sufficient and necessary mediators of VF.⁸

Mediators may derive from ischemic myocytes and from other local tissue (including platelets). Thus, platelets may facilitate VF independently of their role in thrombus formation. Clinical trials suggest the mortality benefit of antiplatelet agents, such as aspirin and $\alpha_{\text{IIb}}\beta_3$ integrin antagonists, may result from effects more complex than simple thrombus inhibition.^{9–11} In animal studies, several platelet-activating factor antagonists^{12–14} reduced ischemia-induced VF incidence. Moreover, aspirin pretreatment reduced ischemia-induced VF in various animal models.^{15–17} However, there is a lack of evidence directly linking anti-VF effects to platelet ablation. It

has been argued that a systematic examination of the role of platelets in VF initiation during ischemia is long overdue.¹⁸

We have tested whether VF is facilitated by the activation of platelets trapped within the ischemic territory, resulting in the release of proarrhythmic secretome. A novel in vitro model system permitted myocardial ischemia to be induced in isolated rat hearts in the absence or presence of an autologous infusion of platelets. When ischemic zone (IZ) was made deliberately suboptimal, platelets facilitated the ability of ischemia to evoke VF, and secretome evoked VF in the absence of ischemia. Facilitation of VF was not attenuated by current clinical antiplatelet therapy.

Methods

Animals and Core Methods

Experiments were performed according to the United Kingdom Home Office Guide to the Operation of the Animals (Scientific Procedures) Act 1986. Heart perfusion, induction of ischemia, verification and quantification of IZ size, and data recording and analysis were as described previously.¹⁹ Male Wistar rats (220–270 g) were anesthetized (pentobarbitone 60 mg/kg IP) and given sodium heparin 250 IU IP. Blood samples (7–10 mL) for platelet preparation were

Received April 24, 2013; accepted August 2, 2013.

From Cardiovascular Division (T.S.D., J.L., J.E.C., M.J.C.), and Division of Imaging Sciences and Medical Engineering (R.A.M., R.S.), King's College London, United Kingdom.

Correspondence to Michael J. Curtis, PhD, FBPharmS, Cardiovascular Division, The Rayne Institute, St Thomas' Hospital, London SE17EH, United Kingdom. E-mail michael.curtis@kcl.ac.uk

© 2013 American Heart Association, Inc.

Circ Arrhythm Electrophysiol is available at <http://circep.ahajournals.org>

DOI: 10.1161/CIRCEP.113.000591

drawn by inferior vena caval puncture and collected into acid citrate dextrose buffer (120 mmol/L sodium citrate, 110 mmol/L glucose, 80 mmol/L citric acid). Rats were then killed by cardiac excision, and hearts excised, immersed in cold (4°C) Krebs solution (modified to contain 3 mEq/L K⁺ and 1.4 mEq/L Ca⁺⁺), then cannulated for perfusion with similar Krebs solution (gassed with 95% O₂ plus 5% CO₂) at 37°C at a constant pressure (70 mm Hg). A silver electrogram (ECG) lead was positioned to impale a part of the anterior surface of the left ventricle that, from our experience, would be subserved by the artery to be occluded. The ECG was recorded (PowerLab; ADInstruments, United Kingdom) at a sampling rate of 2 kHz and with high- and low-pass frequency filters set at 0.3 Hz and 1 kHz. The standard definitions of rat ECG intervals were used.²⁰ Experimental guiding principles and arrhythmia definitions were as described in the Lambeth Conventions.²¹ Coronary flow (CF) was measured by timed collection of coronary effluent. A silk suture (3/0 thread), sewn under the left main artery immediately after setup, was tightened to achieve regional ischemia, and the size of the IZ was determined at the end of perfusion using the disulphine blue method.¹⁹

Platelet Preparation and Control Groups

Washed platelets were derived by centrifugation, resuspended (2×10⁸/mL) in Krebs solution, then rested for ≥10 minutes before use. To validate platelet viability and aggregability when suspended in Krebs solution (the preparation method is validated only with Tyrode solution), platelet aggregometry was performed²² using fibrillar type I horn collagen (Nycomed, Axis-Shield, United Kingdom), thrombin (Sigma, Poole, United Kingdom), and ADP (Sigma).

Three control groups were used in the first of 2 studies: platelet vehicle control solution (Krebs), fluorospheres, and secretome. The fluorosphere control group tested whether any increase in arrhythmias in the platelet group was mediated by the mere presence of platelet-sized particles. The fluorospheres (Invitrogen, Paisley, United Kingdom) mimic platelet size and charge. Platelet secretome controls tested whether secretome facilitates ischemia-induced VF and whether secretome could evoke VF in the absence of ischemia. Secretome contains substances (eg, ATP, serotonin, histamine, and >300 proteins),²³ many of which can alter cardiac electrophysiology.²⁴ To obtain secretome, the washed platelet pellet was resuspended in 4 mL Krebs solution and stimulated with 1 U/mL thrombin. The aggregated suspension was then centrifuged (1000g for 3 minutes) and the secretome collected.

Platelets, fluorospheres, and secretome were prepared in 4 mL of warmed, gassed Krebs solution immediately before infusion and contained 2×10⁸/mL platelets, 4×10⁹/mL fluorospheres, or (as quantified by Bradford assay) 0.21 mg/mL protein, respectively.

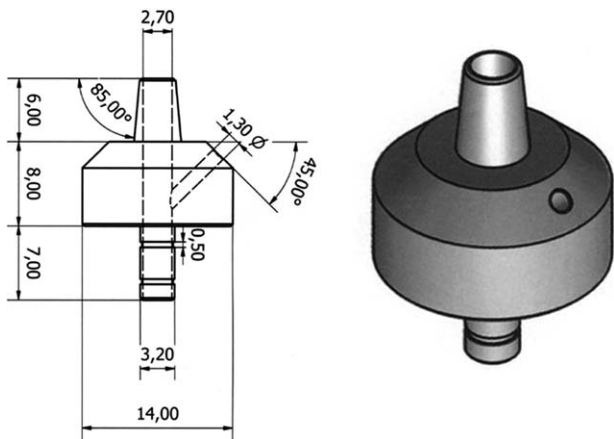

Figure 1. Novel cannula engineered for direct platelet delivery to the isolated heart. A modified Langendorff cannula was made from stainless steel and modified to receive a sidearm to allow passage of an inert 1-mm internal diameter polypropylene tube to the tip of the cannula. The shear rate within the sidearm tubing was subarteriolar (<1000/s).

Platelet Delivery System

A Langendorff cannula was modified to allow infusion of washed platelets into the perfusate in a nonactivated and functional state (Figure 1). Platelets, platelet vehicle, fluorospheres, or secretome were delivered as infusion solutions to the cannula from polypropylene syringes attached to a syringe driver.

Experimental Design

In the first study, platelets were trapped in the IZ by coronary ligation. To validate the method, hearts were perfused with platelets radiolabeled with 50 MBq ¹¹¹In oxine sulfate. After coronary ligation, hearts were frozen in liquid nitrogen for autoradiography to be performed on 20-μm sections exposed to CL-Xposure Film (Thermo Fisher Scientific, Loughborough, United Kingdom) for 3 days. Then, 96 rats were randomized into 8 groups: Krebs solution controls, washed platelets, platelet secretome or fluorospheres, each with coronary ligation or sham ligation. All hearts were perfused for 30 minutes with

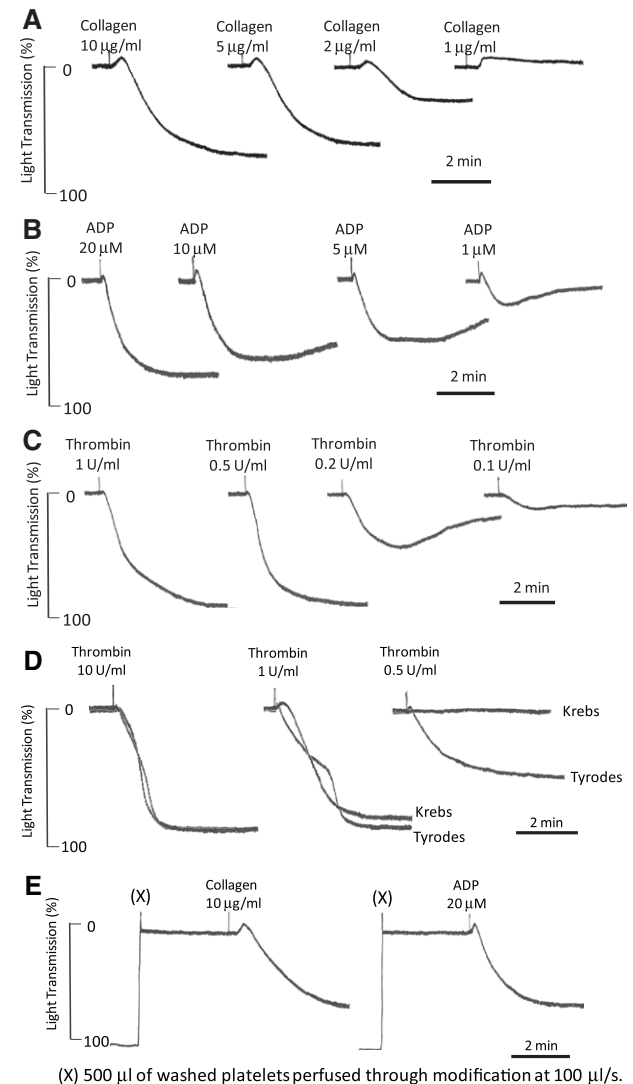

Figure 2. Platelet aggregation studies confirm platelet viability and functionality. Washed rat platelets were derived by standard centrifugation and resuspended at a concentration of 2×10⁸/mL. Aggregation traces demonstrated normal dose–response curves to agonist stimulation with collagen, ADP, and thrombin in Tyrode solution (A–C) or Krebs solution (D and E). E, X refers to the time point at which 500 μL of washed platelets were perfused through the modification to the cannula at 100 μL/s. All traces are representative of n=3.

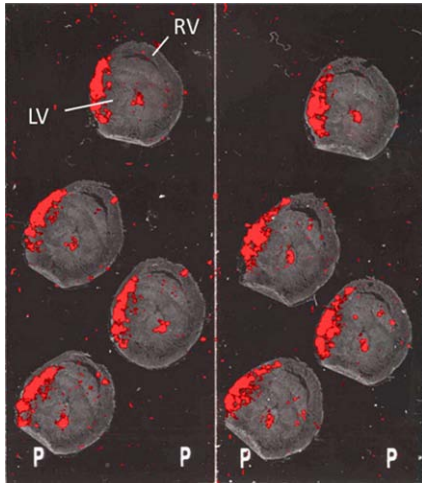

Figure 3. The delivery of platelets is sufficient to cause platelet trapping. To validate the platelet delivery/trapping method, rat hearts were perfused with platelets radiolabelled with 50 MBq ^{111}In oxine sulfate. After coronary ligation, hearts were frozen in liquid nitrogen for autoradiography to be performed on 20- μm sections. Platelets were trapped by coronary ligation in the ischemic zone (left ventricle, LV) and excluded (little adhesion) in the remote region (right ventricle, RV). Representative image of $n=3$.

Krebs solution, then infusion solution was delivered at 0.2 mL/min for 20 minutes, with coronary ligation (or sham ligation) performed at the half way point (10 minutes).

Thromboxane Assay

In separate groups of hearts, at the end of platelet infusion (after 10-minute ischemia), the ligature was released and coronary effluent collected for 60 seconds. Thromboxane (TX) B_2 was measured by ELISA assay (Biotrak thromboxane B2 enzyme immunoassay system; GE Healthcare, Amersham, United Kingdom). The TX measured is a marker of platelet activation and degranulation²⁵ during ischemia and is not reperfusion-induced release, because true reperfusion-induced platelet adhesion and activation takes several minutes to manifest.²⁶

Drug Administration and Blood Trapping

In a second study, an equivalent protocol was used to explore the ability of whole blood to mimic the ability of trapped platelets to facilitate ischemia-induced VF and to test the effects of standard antiplatelet drugs. A blood sample was taken before cardiac excision, heparinized (0.1 U/mL), then delivered via the system used earlier (4 mL, >20 minutes, at a rate of 0.2 mL/min), with coronary ligation and blood trapping performed half way through the infusion. Rats received PO indomethacin ($n=14$; 2.4 mg/kg per day; Sigma), clopidogrel ($n=9$; 10 mg/kg per day; Wockhardt, Wrexham, United Kingdom), or vehicle ($n=20$; 1 mL/kg per day of 4% v/v ethanol in

distilled water) for a minimum of 5 consecutive days. The vehicle group was subdivided to provide blood-trapped ($n=8$) and blood-free (Krebs solution throughout; $n=12$) controls.

Exclusion Criteria

Based on previously published standards, hearts were excluded if preligation sinus heart rate (HR) was <200 beats/minute or CF was <5 mL/min,²⁷ or if IZ was outside the range of 25% to 40% of total ventricular weight, or VF occurred before the onset of ischemia. VF susceptibility in individual hearts is not dependent on baseline HR or CF beyond these stated exclusion limits.²⁷ Blood-perfused hearts were excluded if they developed an intracoronary thrombus before coronary ligation. The studies required 204 rats, of which 12 were excluded.

Statistical Analyses

Parametric variables (\pm SEM), including CF, HR, PR interval, QT interval at 90% repolarization (QT90),²⁰ and light transmission for platelet aggregation, were evaluated by 1-way ANOVA and Dunnett test to compare treatments with control. Incidences of ventricular tachycardia and VF (dichotomous variables) were analyzed by Fisher exact test because of small sample sizes. This test was used for global multiple comparisons, and if significant, a pairwise comparison was performed versus controls using the same test. Other nonparametric variables were analyzed using the Steel–Dwass test, and the Kruskal–Wallis test was used for the estimation of stochastic probability in intergroup comparisons. Probability values were 2-sided and results were deemed statistically significant when $P<0.05$. Statistical analyses were performed on R, version 2.14.

Results

Delivered Platelets Were Viable and Functional

Aggregation traces demonstrated normal dose–response curves to agonists (Figure 2A–C), and 1 U/mL of thrombin induced a maximal aggregation response (Figure 2D). Washed platelets were nonactivated on exiting the delivery system setup without a heart attached, but could be fully activated by agonist stimulation (Figure 2E), validating the platelet delivery system and Krebs solution as a platelet vehicle.

Platelet Trapping Facilitates Ischemia-Induced VF

Coronary ligation trapped infused platelets within the IZ (Figure 3). Mean IZ values (33%–35%) were suboptimal for VF (Table 1), meaning that ischemia-induced VF occurred in only 42% of platelet-free controls as desired.²⁸ Platelet trapping increased VF incidence to 91% ($P<0.05$), whereas trapping of secretome or fluorospheres had no such effect (Figure 4). Delivery of platelets in the absence of ischemia did not elicit VF (either in shams, or preischemia in hearts with

Table 1. Baseline Characteristics of Hearts Subjected to Coronary Ligation

Baseline Variables (Value \pm SEM)	Krebs Buffer (N=12)	Platelet (N=11)	Secretome (N=12)	Fluorospheres (N=10)	P Value
Heart rate, beats/min	264.4 \pm 8.9	278.5 \pm 8.9	280.1 \pm 12.4	287.0 \pm 13.3	0.89
Coronary flow, mL/min	10.1 \pm 0.7	9.7 \pm 0.7	10.0 \pm 0.7	10.7 \pm 0.6	0.73
PR interval, ms	38.2 \pm 1.2	39.7 \pm 2.4	37.6 \pm 0.8	39.2 \pm 1.8	0.82
QT90 interval, ms	53.3 \pm 1.8	48.5 \pm 2.3	55.2 \pm 2.2	52.3 \pm 1.9	0.59
IZ, % of ventricular mass	34.1 \pm 0.8	33.0 \pm 0.7	34.2 \pm 1.0	34.6 \pm 0.8	0.64

IZ indicates ischemic zone.

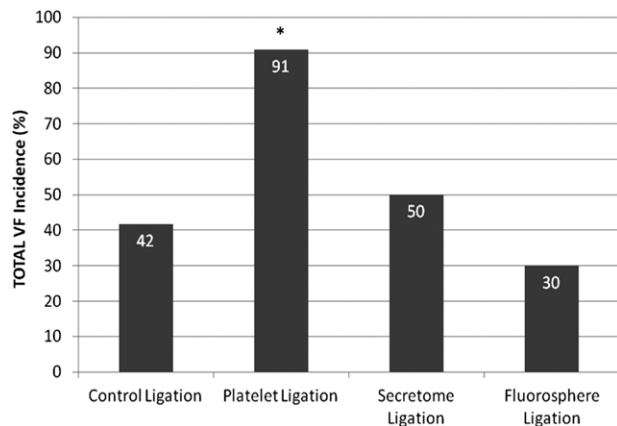

Figure 4. Platelet trapping facilitates ischemia-induced ventricular fibrillation (VF). Incidence of VF evoked by 30-min regional ischemia in the Langendorff-perfused rat heart. Platelets, secretome, or fluorospheres were delivered for 20 min beginning 10 min before the start of ischemia. * $P < 0.05$ vs controls.

coronary ligation). However, 2 sham coronary-ligated hearts experienced VF during secretome infusion.

Hemodynamic and ECG Variables in Platelet Trapping Study

Baseline HR, CF, PR, and QT90 intervals did not differ between the 4 groups (Table 2) here (and elsewhere in the study). Coronary ligation evoked changes typical for the model, such as a fall in CF. There were no significant differences in CF or PR between groups at any time. The QT90 interval in coronary-ligated controls increased during ischemia from 53 ± 2 to 68 ± 3 ms, then gradually fell toward the end of the experiment to 61 ± 3 ms, as seen previously with this model.^{19,20,29} QT90 changes were similar with platelet trapping, but the increase was significantly greater versus the other groups 30 minutes after the onset of ischemia (platelet, 71 ± 4 ms; control, 61 ± 3 ms; secretome, 64 ± 4 ms; fluorospheres, 59 ± 4 ms; $P < 0.05$). In sham ligation controls, there were no significant effects of platelet or secretome infusion on CF, PR, or QT90. The only HR variation between groups was a transient increase at the start of secretome infusion in sham (Figure 5A) and coronary-ligated hearts (Figure 5B) with a weaker (nonsignificant) trend toward an increase in hearts with platelets trapped by ligation (Figure 5B).

Regional Ischemia Activates Platelets

In Krebs solution-perfused control hearts subjected to coronary ligation, no TX was detected in coronary effluent. However, in hearts with platelets trapped in the IZ, a substantial amount of TX was detected (Figure 6).

Drug Pretreatment Action on Platelets, VF, and Hemodynamics

Oral pretreatment with antiplatelet agents inhibited (but did not abolish) ex vivo aggregation responses to ADP (Figure 7A) and thrombin (Figure 7B). CF, HR, PR interval, QT90 interval, and IZ size were similar to values in the platelet trapping study and did not vary significantly between groups (Table 3). Ischemia-induced VF was facilitated by blood trapping compared with blood-free controls ($P < 0.05$; Figure 8). Facilitation of VF was not reduced significantly by pretreatment in vivo with clopidogrel ($P > 0.05$) or indomethacin ($P > 0.05$; Figure 8).

Discussion

Overview

Platelets trapped in the IZ by coronary ligation became activated by ischemia, resulting in an increase in VF incidence in hearts in which VF risk would ordinarily be low due to suboptimal ischemia (small IZ). Platelets were arrhythmogenic only when trapped in the IZ. Trapping of autologous whole blood mimicked the platelet effect. This was not prevented by in vivo pretreatment with clopidogrel or indomethacin (which reduced platelet aggregability). Platelets, platelet trapping, and secretome did not lower CF, precluding the possibility that platelets induced VF by evoking ischemia or rendering it more severe. This is, therefore, the first direct evidence that platelets facilitate VF during ischemia independently of their role in thrombosis.

Platelets and the Pathophysiological Reserve for VF

Previous reports on platelet involvement in VF are contradictory. Pretreatment with aspirin, ticlopidine, meclofenamate, or indomethacin reduced ischemia-induced VF incidence from a high baseline in anesthetized rats.^{15,16} However, aspirin failed to reduce ischemia-induced VF in conscious rats with a large IZ.³⁰ Likewise, platelet-activating factor antagonists ameliorated ischemia-induced VF in vivo in 2 study,³¹ but not in others.^{32,33} Moreover, platelet-activating factor and platelet-activating factor antagonists possess platelet-independent effects on ischemia-induced VF.²⁸

In most published studies, the IZ was not determined. It is well established that when the IZ is large in vivo and even in Krebs solution-perfused rat hearts, all controls develop VF due to pathophysiological reserve.^{19,20,34} A pathophysiological reserve precludes identification of individual mediators of VF. In the present study, the pathophysiological reserve was reduced by making IZ suboptimal, thereby revealing the pathophysiological ability of trapped platelets to facilitate ischemia-induced VF. The question remaining is to

Table 2. Baseline Characteristics of Sham Hearts in the Platelet-Trapping Study

Baseline Variables (Value \pm SEM)	Krebs Buffer (N=11)	Platelet (N=12)	Secretome (N=11)	Fluorospheres (N=11)	P Value
Heart rate, beats/min	285.8 \pm 14.5	296.3 \pm 12.6	295.5 \pm 12.5	277.0 \pm 14.7	0.81
Coronary flow, mL/min	9.5 \pm 0.8	9.0 \pm 0.9	9.0 \pm 0.8	9.6 \pm 0.5	0.69
PR interval, ms	40.4 \pm 1.4	35.6 \pm 1.3	39.6 \pm 1.4	39.8 \pm 1.3	0.78
QT90 interval, ms	56.5 \pm 3.2	56.5 \pm 1.7	55.1 \pm 1.9	52.1 \pm 2.9	0.63

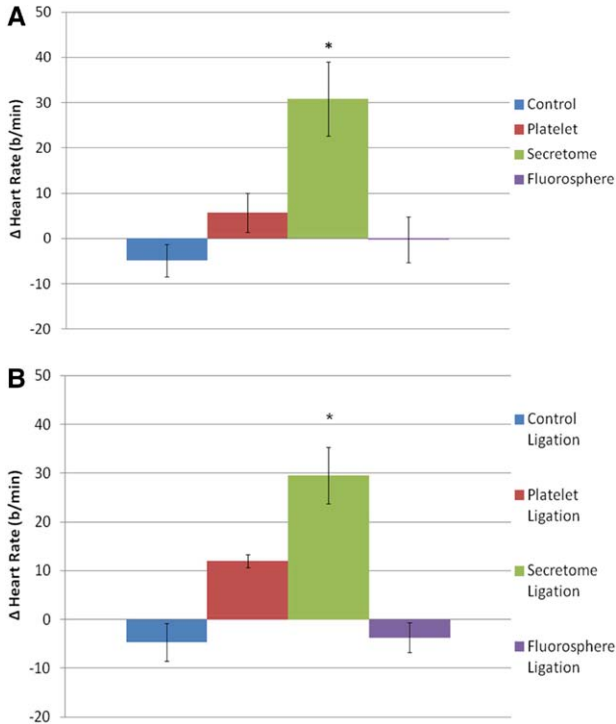

Figure 5. Secretome infusion resulted in fluctuations in heart rate (HR). Rat platelet secretome (0.21 mg/mL protein) in a final volume of 4 mL warmed, gassed Krebs solution was delivered at 0.2 mL/min for 20 min, with coronary ligation (or sham ligation) performed at the half way point (10 min). Secretome consistently increased HR (defined as any change sustained for ≥ 10 sec) compared with the maximum changes during the equivalent time interval in other groups of sham (A) or coronary-ligated (B) hearts. * $P < 0.05$ vs controls.

what extent does this knowledge inform better drug targeting of VF?

Mechanistic Insights

The increase in QT90 interval in hearts with platelets trapped in the IZ resonates with data from De Jong and Dekker¹⁸ who exposed human platelet secretome to rabbit cardiomyocytes and observed action potential duration prolongation and after-depolarizations. However, other findings provide better clues to mechanisms.

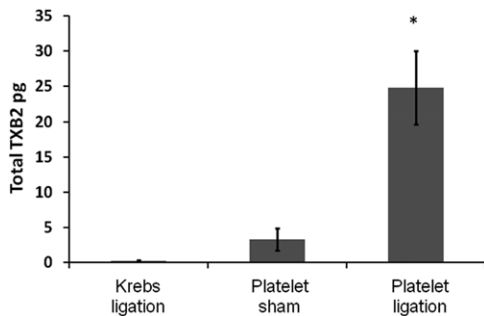

Figure 6. Regional ischemia activates platelets. Rat hearts underwent 10-min ischemia or sham ligation. In 2 groups, platelets were delivered for 20 min beginning 10 min before the start of ischemia or sham ligation. Thromboxane B₂ was measured by ELISA in the coronary effluent collected during the first minute after cessation of infusion of platelets (ligation or sham). * $P < 0.05$ vs Krebs ligation (no platelets).

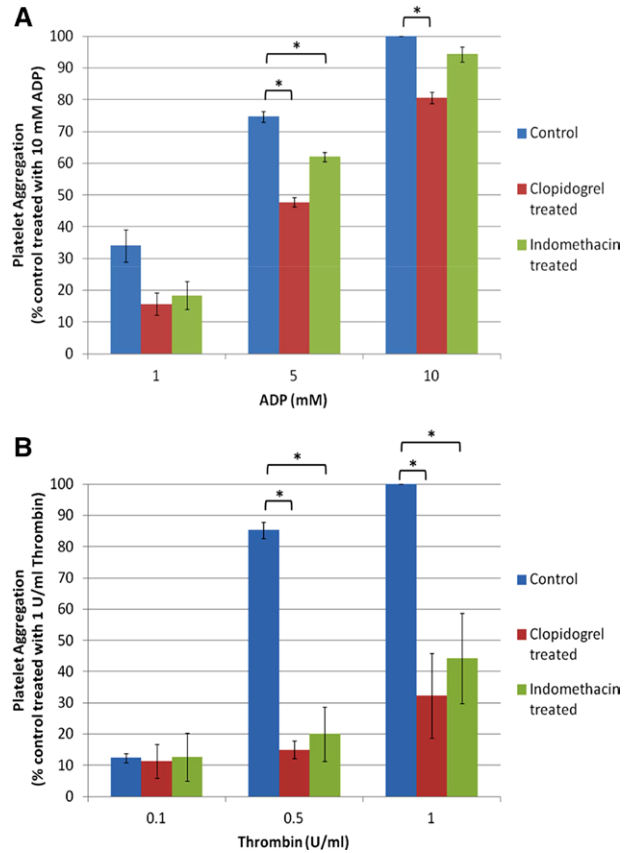

Figure 7. Effects of drug pretreatment on platelet aggregation. Rats were pretreated with indomethacin or clopidogrel for a minimum of 5 days. Washed platelets were derived by standard centrifugation and resuspended in Krebs solution at 2×10^9 /mL. Platelet aggregation responses to (A) ADP (n=3) and (B) thrombin (n=3) are shown. * $P < 0.05$ vs controls.

Platelets were inert in nonischemic hearts, so the mechanism of VF facilitation required an interaction with components of the ischemic milieu. Additionally, platelet-sized fluorospheres were not arrhythmogenic (in shams or when trapped by ligation), confirming that VF facilitation by platelets does not operate by simple physical presence.

Trapped platelets released TX in the present study. Moreover, in 2 sham hearts (no ischemia), exogenously administered secretome caused VF. In our historical database of $n > 200$ controls, otherwise normal hearts do not exhibit spontaneous VF. The mechanism was primary, because secretome did not induce ischemia (no reduction in CF) in shams. The secretome effect in shams contrasts with the lack of platelet and blood effects. Conversely, secretome had little effect when trapped in the IZ, in sharp contrast to the facilitation of VF by trapped platelets and blood.

These observations provide coherent mechanistic insight: ischemia activates trapped platelets to release secretome containing a labile and short-lived arrhythmogenic mediator, sufficient to facilitate VF when IZ is suboptimal. It is important to emphasize that these mechanistic insights are tentative.

Clinical Relevance

Due to the complex interaction between platelets and other blood components, we modified our platelet-trapping

Table 3. Baseline Characteristics of Hearts Subjected to Coronary Ligation in the Blood-Trapping Study

Baseline Variables (Value±SEM)	Krebs Buffer (N=12)	Blood (N=8)	Clopidogrel (N=9)	Indomethacin (N=14)	P Value
Heart rate, beats/min	304.3±7.3	290.9±9.1	282.3±7.5	265.0±11.8	0.56
Coronary flow, mL/min	9.9±0.4	10.1±0.4	11.4±0.6	10.2±0.8	0.51
PR interval, ms	36.6±1.3	42.6±0.9	39.9±0.9	40.8±1.8	0.74
QT90 interval, ms	54.8±1.5	63.4±2.5	57.8±3.1	60.7±4.8	0.49
IZ, % of ventricular mass	31.6±2.0	35.0±1.3	31.0±1.5	32.4±0.1	0.38

IZ indicates ischemic zone.

approach to examine whether standard antiplatelet drugs administered in vivo could reduce the ability of trapped whole blood to facilitate VF in vitro. Clopidogrel and indomethacin were not effective in this regard. Clopidogrel reduces platelet P-selectin expression, but does not prevent platelets from secreting α -granular contents; indomethacin inhibits cyclooxygenase, but is not selective for TX synthesis.^{35,36} Moreover, despite high dosage, the effect of each drug on responses to platelet activators in vitro, although significant, was not substantial. Thus, standard antiplatelet drugs are unable to affect ischemia-trapped platelet function sufficiently to block facilitation of VF. This agrees with their lack of benefit against sudden cardiac death in humans.

Limitations

The isolated perfused unloaded rat heart exhibits ischemic VF, which is not subject to normal mechanical or autonomic influences. Confidence that present findings have clinical relevance is limited by the extent to which the lack of loading and intact innervation may change the ability of platelets to facilitate ischemia-induced VF in suboptimal ischemia. To test this, in vivo experimentation will be required.

Future Work

There are a large number of constituents of the platelet secretome, and identification of the one(s) necessary for facilitation of VF is beyond the scope of the present study. TXA₂ is a noteworthy

labile and short-lived constituent. In addition to our evidence of ischemia-specific TX release from platelets trapped in the IZ, studies with the TX synthase blockers, UK38485, R-68070, and U-63557A,^{25,37} suggest that TXA₂ may facilitate ischemia-induced VF in vivo. Together, this justifies future work to clarify links between the platelet, TX, and ischemia-induced VF.

Acknowledgments

We thank Sarah Murden for technical assistance.

Sources of Funding

This research was supported by the National Institute for Health Research, the British Heart Foundation (pump-priming grant D-BHF-RE/08/003 and project grant PG/10/20/28211).

Disclosures

None.

References

1. Chugh SS, Reinier K, Teodorescu C, Evanado A, Kehr E, Al Samara M, Mariani R, Gunson K, Jui J. Epidemiology of sudden cardiac death: clinical and research implications. *Prog Cardiovasc Dis*. 2008;51:213–228.
2. Myerburg RJ. Sudden cardiac death: exploring the limits of our knowledge. *J Cardiovasc Electrophysiol*. 2001;12:369–381.
3. John RM, Tedrow UB, Koplman BA, Albert CM, Epstein LM, Sweeney MO, Miller AL, Michaud GF, Stevenson WG. Ventricular arrhythmias and sudden cardiac death. *Lancet*. 2012;380:1520–1529.
4. Waldo AL, Camm AJ, deRuyter H, Friedman PL, MacNeil DJ, Pauls JF, Pitt B, Pratt CM, Schwartz PJ, Veltri EP; The SWORD Investigators. Effect of d-sotalol on mortality in patients with left ventricular dysfunction after recent and remote myocardial infarction. Survival with Oral d-Sotalol. *Lancet*. 1996;348:7–12.
5. Echt DS, Liebson PR, Mitchell LB, Peters RW, Obias-Manno D, Barker AH, Arensberg D, Baker A, Friedman L, Greene HL. Mortality and morbidity in patients receiving encainide, flecainide, or placebo. The Cardiac Arrhythmia Suppression Trial. *N Engl J Med*. 1991;324:781–788.
6. Camm AJ, Julian D, Janse G, Munoz A, Schwartz P, Simon P, Frangin G; EMIAT Investigators. The European Myocardial Infarct Amiodarone Trial (EMIAT). *Am J Cardiol*. 1993;72:95F–98F.
7. Clements-Jewery H, Andrag E, Curtis MJ. Druggable targets for sudden cardiac death prevention: lessons from the past and strategies for the future. *Curr Opin Pharmacol*. 2009;9:146–153.
8. Curtis MJ, Pugsley MK, Walker MJ. Endogenous chemical mediators of ventricular arrhythmias in ischaemic heart disease. *Cardiovasc Res*. 1993;27:703–719.
9. ISIS-2 (Second International Study of Infarct Survival) Collaborative Group. Randomised trial of intravenous streptokinase, oral aspirin, both, or neither among 17,187 cases of suspected acute myocardial infarction: ISIS-2. *Lancet*. 1988;8607:349–360.
10. Askari AT, Lincoff AM. GUSTO V: combination drug treatment of acute myocardial infarction. Global use of strategies to open occluded coronary arteries. *Cleve Clin J Med*. 2002;69:554–560.
11. Lincoff AM, Califf RM, Van de Werf F, Willerson JT, White HD, Armstrong PW, Guetta V, Gibler WB, Hochman JS, Bode C, Vahanian A, Steg PG, Ardissino D, Savonitto S, Bar F, Sadowski Z, Betriu A, Booth

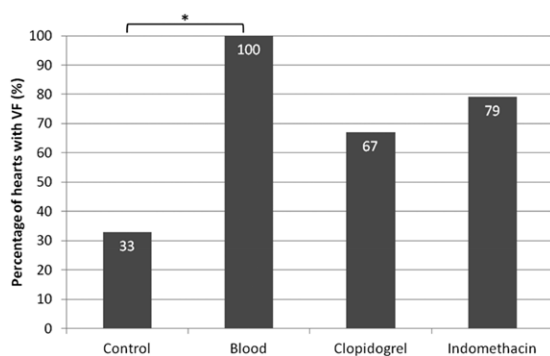

Figure 8. Incidence of ventricular fibrillation (VF) in antiplatelet drug pretreated study. Incidence of VF evoked by 30-min regional ischemia in the Langendorff-perfused rat heart. Rats were pretreated for ≥ 5 days in vivo with drug or vehicle. Autologous blood was delivered for 20 min beginning 10 min before the start of ischemia. Blood trapping was associated with a high incidence of VF ($*P < 0.05$ vs control hearts without blood trapping). VF incidence with blood trapping was not significantly reduced by clopidogrel or indomethacin pretreatment in vivo.

- JE, Wolski K, Waller M, Topol EJ. Mortality at 1 year with combination platelet glycoprotein IIb/IIIa inhibition and reduced-dose fibrinolytic therapy vs conventional fibrinolytic therapy for acute myocardial infarction: GUSTO V randomized trial. *JAMA*. 2002;288:2130–2135.
12. Koltai M, Tosaki A, Hosford D, Esanu A, Braquet P. Effect of BN 50739, a new platelet activating factor antagonist, on ischaemia induced ventricular arrhythmias in isolated working rat hearts. *Cardiovasc Res*. 1991;25:391–397.
 13. Stahl GL, Terashita Z, Lefer AM. Role of platelet activating factor in propagation of cardiac damage during myocardial ischemia. *J Pharmacol Exp Ther*. 1988;244:898–904.
 14. Auchampach JA, Maruyama M, Cavero I, Gross GJ. The new K⁺ channel opener Aprikalim (RP 52891) reduces experimental infarct size in dogs in the absence of hemodynamic changes. *J Pharmacol Exp Ther*. 1991;259:961–967.
 15. Ahn YK, Cho JG, Park WS, Kim NH, Kim JW, Kim SH, Cho JH, Park JH, Jeong MH, Park JC, Kang JC. The effects of antiplatelet agents in the prevention of ventricular tachyarrhythmias during acute myocardial ischemia in rats. *Jpn Heart J*. 1999;40:79–86.
 16. Fagbemi SO. The effect of aspirin, indomethacin and sodium meclofenamate on coronary artery ligation arrhythmias in anaesthetized rats. *Eur J Pharmacol*. 1984;97:283–287.
 17. Moschos CB, Haider B, De La Cruz C, Lyons MM, Regan TJ. Antiarrhythmic effects of aspirin during nonthrombotic coronary occlusion. *Circ*. 1978;57:681–684.
 18. De Jong JSSG, Dekker LRC. Platelets and cardiac arrhythmia. *Frontiers Physiol*. 2010;1:166.
 19. Curtis MJ, Hearse DJ. Reperfusion-induced arrhythmias are critically dependent upon occluded zone size: relevance to the mechanism of arrhythmogenesis. *J Mol Cell Cardiol*. 1989;21:625–637.
 20. Curtis MJ. Characterisation, utilisation and clinical relevance of isolated perfused heart models of ischaemia-induced ventricular fibrillation. *Cardiovasc Res*. 1998;39:194–215.
 21. Curtis MJ, Hancox JC, Farkas A, Wainwright CL, Stables CL, Saint DA, Clements-Jewery H, Lambiasi PD, Billman GE, Janse MJ, Pugsley MK, Ng GA, Roden DM, Camm AJ, Walker MJ. The Lambeth Conventions (II): guidelines for the study of animal and human ventricular and supra-ventricular arrhythmias. *Pharmacol Ther*. 2013;139:213–248.
 22. Dhanjal TS, Ross EA, Auger JM, McCarty OJ, Hughes CE, Senis YA, Buckley CD, Watson SP. Minimal regulation of platelet activity by PECAM-1. *Platelets*. 2007;18:56–67.
 23. Coppinger JA, Cagney G, Toomey S, Kislinger T, Belton O, McRedmond JP, Cahill DJ, Emili A, Fitzgerald DJ, Maguire PB. Characterization of the proteins released from activated platelets leads to localization of novel platelet proteins in human atherosclerotic lesions. *Blood*. 2004;103:2096–2104.
 24. Flores NA, Botchway AN, Stavrou BM, Sheridan DJ. Cardiac electrophysiological effects of platelet-derived substances. *Exp Physiol*. 1999;84:253–274.
 25. Coker SJ, Parratt JR, Ledingham IM, Zeitlin IJ. Thromboxane and prostacyclin release from ischaemic myocardium in relation to arrhythmias. *Nature*. 1981;291:323–324.
 26. Leo R, Praticò D, Iuliano L, Pulcinelli FM, Ghiselli A, Pignatelli P, Colavita AR, FitzGerald GA, Violi F. Platelet activation by superoxide anion and hydroxyl radicals intrinsically generated by platelets that had undergone anoxia and then reoxygenated. *Circulation*. 1997;95:885–891.
 27. Clements-Jewery H, Hearse DJ, Curtis MJ. Independent contribution of catecholamines to arrhythmogenesis during evolving infarction in the isolated rat heart. *Br J Pharmacol*. 2002;135:807–815.
 28. Ridley PD, Yacoub MH, Curtis MJ. A modified model of global ischaemia: application to the study of syncytial mechanisms of arrhythmogenesis. *Cardiovasc Res*. 1992;26:309–315.
 29. Baker KE, Wood LM, Whittaker M, Curtis MJ. Nupafant, a PAF-antagonist prototype for suppression of ventricular fibrillation without liability for QT prolongation? *Br J Pharmacol*. 2006;149:269–276.
 30. Johnston KM, MacLeod BA, Walker MJ. Effects of aspirin and prostacyclin on arrhythmias resulting from coronary artery ligation and on infarct size. *Br J Pharmacol*. 1983;78:29–37.
 31. Auchampach JA, Pieper GM, Cavero I, Gross GJ. Effect of the platelet-activating factor antagonist RP 59227 (Tulopafant) on myocardial ischemia/reperfusion injury and neutrophil function. *Basic Res Cardiol*. 1998;93:361–371.
 32. Wainwright CL, Parratt JR, Bigaud M. The effects of PAF antagonists on arrhythmias and platelets during acute myocardial ischaemia and reperfusion. *Eur Heart J*. 1989;10:235–243.
 33. Chakrabarty S, Fluck DS, Flores NA, Sheridan DJ. Effects of the PAF antagonists BN50726 and BN50739 on arrhythmogenesis and extent of necrosis during myocardial ischaemia/reperfusion in rabbits. *Br J Pharmacol*. 1992;107:705–709.
 34. Clements-Jewery H, Andrag E, Hearse DJ, Curtis MJ. Complex adrenergic and inflammatory mechanisms contribute to phase 2 ventricular arrhythmias in anaesthetized rats. *Br J Pharmacol*. 2009;156:444–453.
 35. Yong AS, Pennings GJ, Chang M, Hamzah A, Chung T, Qi M, Brieger D, Behnia M, Krilis SA, Ng MK, Lowe HC, Kritharides L. Intracoronary shear-related up-regulation of platelet P-selectin and platelet-monocyte aggregation despite the use of aspirin and clopidogrel. *Blood*. 2011;117:11–20.
 36. Moshfegh K, Redondo M, Julmy F, Wuillemin WA, Gebauer MU, Haerberli A, Meyer BJ. Antiplatelet effects of clopidogrel compared with aspirin after myocardial infarction: enhanced inhibitory effects of combination therapy. *J Am Coll Cardiol*. 2000;36:699–705.
 37. De Clerck F, Beetens J, Van de Water A, Vercammen E, Janssen PA. R 68 070: thromboxane A2 synthetase inhibition and thromboxane A2/prostaglandin endoperoxide receptor blockade combined in one molecule—II. Pharmacological effects *in vivo* and *ex vivo*. *Thromb Haemost*. 1989;61:43–49.

CLINICAL PERSPECTIVE

Acute myocardial ischemia (MI) may result in ventricular fibrillation (VF) and sudden death, often with a brief interlude between MI onset and death (hence the out-of-hospital prevalence), confirmed as ≈ 5 to 20 minutes by numerous animal model studies. This brief interlude necessitates pretreatment of those at risk. Unfortunately, available drugs are limited in utility due to safety or efficacy issues. New approaches/targets are needed. Animal studies show that the MI region produces or accumulates numerous pathological mediators that may facilitate ischemia-induced VF. Using blood-free perfused rat hearts, we made ischemic territory sufficiently small ($34 \pm 1\%$ of left ventricle) to evoke VF in only 42% of controls. Importantly, VF incidence was increased to 91% ($P < 0.05$) by coronary ligation-induced trapping of freshly prepared autologous platelets (trapping confirmed by ^{111}In -labeled platelet autoradiographic imaging) without any change in ischemic territory. The trapped platelets released thromboxane, a component of platelet secretome. Freshly prepared secretome evoked VF in 2 nonischemic hearts. Trapping autologous whole heparinized blood mimicked the ability of trapped platelets to increase VF incidence. The effect was not prevented by > 5 days oral pretreatment *in vivo* with clopidogrel (10 mg/kg per day) or indomethacin (2.4 mg/kg per day). This is the first evidence that platelets facilitate VF during acute MI independently of their ability to participate in occlusive thrombosis. Moreover, because the effect is unresponsive to commonly used antiplatelet drugs, we propose that platelet secretome (its release or its receptor-mediated actions) represents a new target for drug discovery in acute MI, for much sought prophylaxis against VF-related sudden death.